

# HEAT TRANSFER COMPACT UNIT

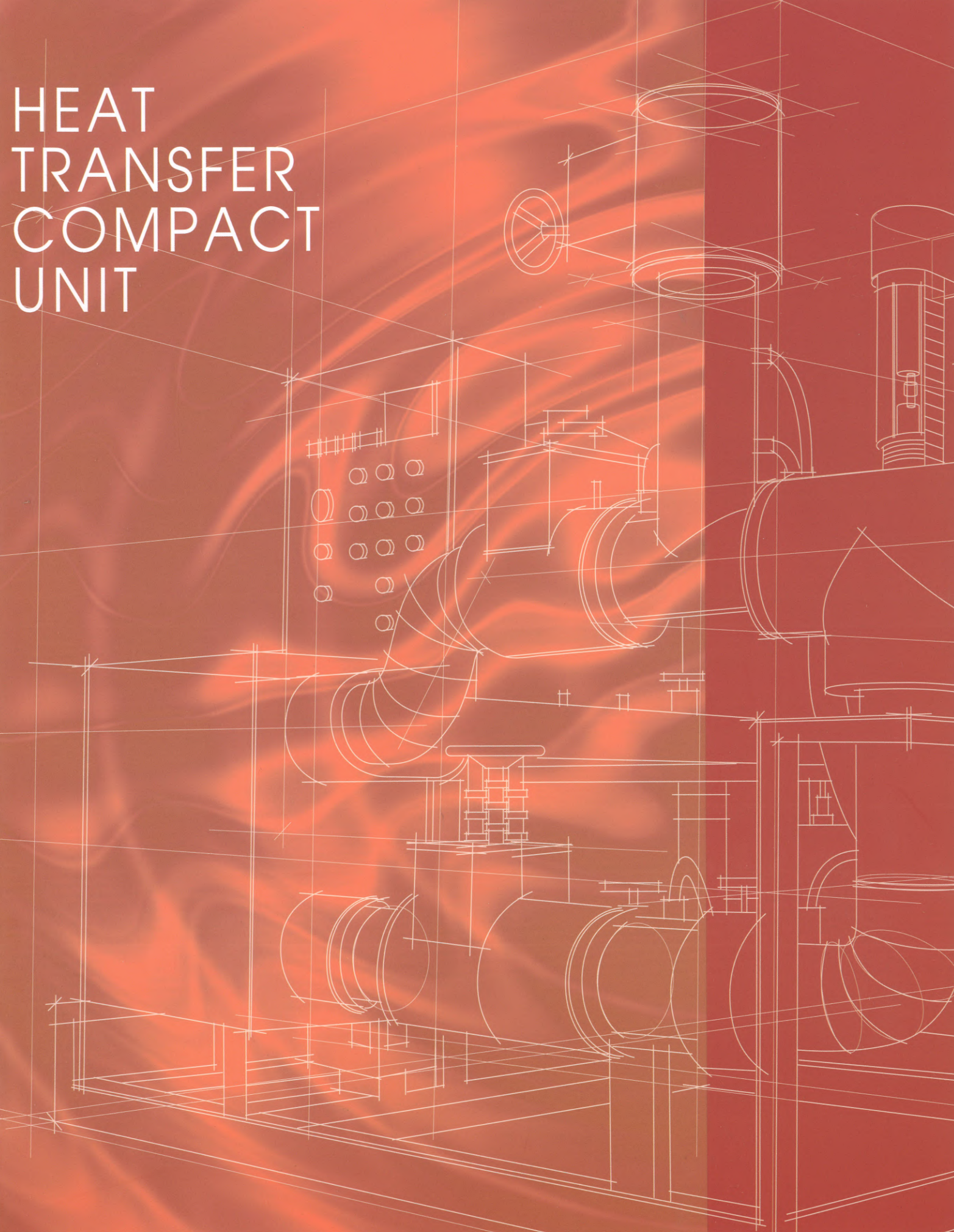



# IES HEAT TRANSFER COMPACT UNIT

With over 10 years of experience in design, manufacture and installation of high quality Heat Transfer Compact Unit, we provide quality and reliable service.

**IES** is committed to provide high quality systems, comprehensive service and continuous improvement of products to meet total customer satisfaction worldwide.

We deploy R&D resources to continuously enhance our product efficiency and we commit to train and develop our people at all levels of the company.

We offer a full suite of pump set and plate heat exchangers together with the control logic system, which enhances our product portfolio to meet your unique business needs.

**IES** Compact Unit is supplied in skid mount and custom designed to suit all site conditions and technical requirements. The unit includes heat exchanger, circulation hot water pump, temperature controller, energy meter, pre-insulated pipe work with aluminum cladding, PID control valve, strainer, non return valve, pneumatic vessel, safety relief valve, high temperature cut off, and built in programmable logic controller.

Our quality assurance team conducts control logic, temperature, and hydraulic tests to ensure the performance and durability of the system fulfills your requirements at the highest standard. On-site testing & commissioning is compliant with the **IES** O&M manual. We also include trouble shooting measures, the manufacturers testing record and a maintenance checklist for future maintenance service.

The compact unit can withstand up to 25 bar working pressure and 180°C working temperature.





# BENEFITS OF IES HEAT TRANSFER COMPACT UNIT

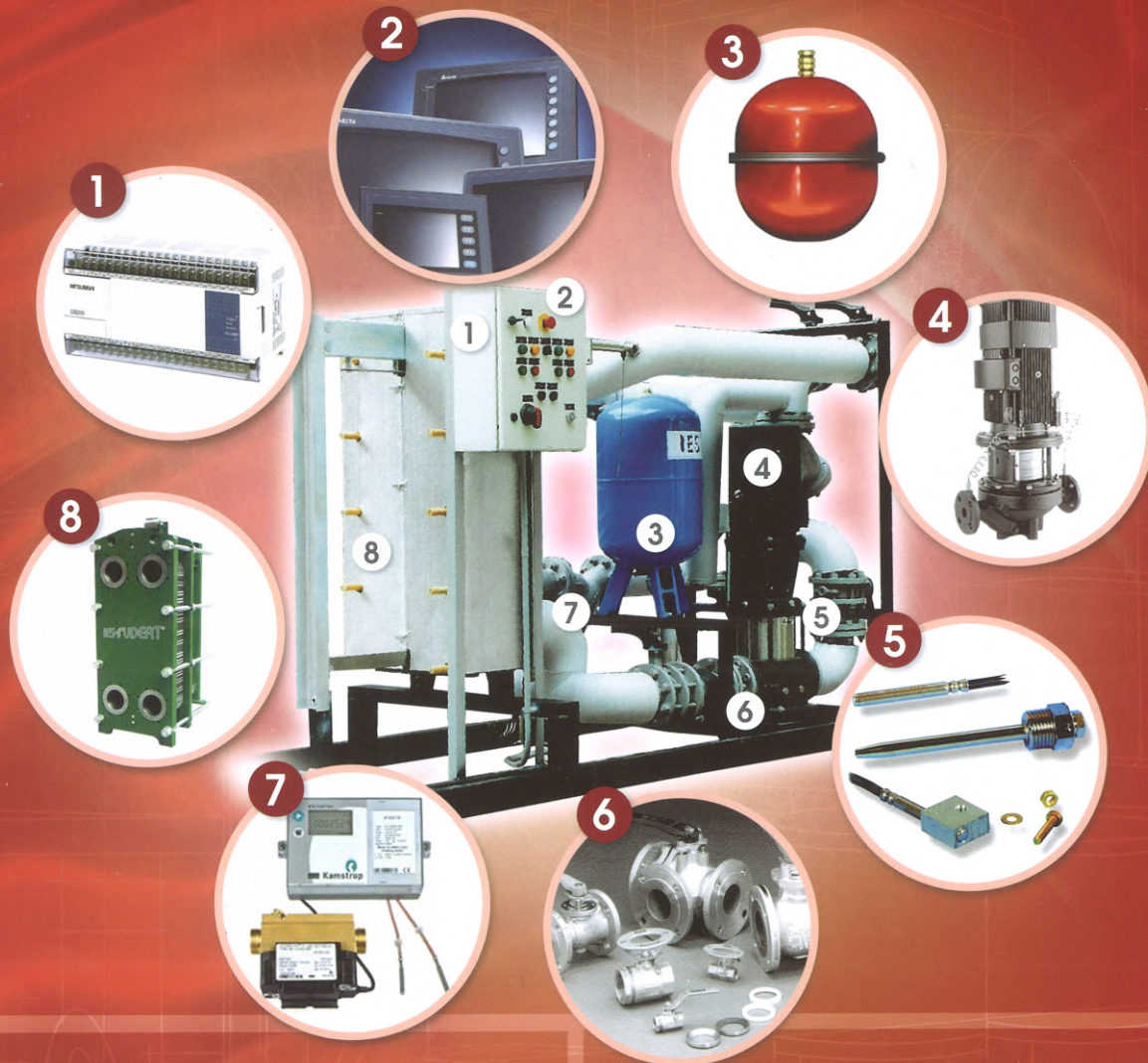

## Compact Design

makes it possible to save up to 50% of the space occupied by loose components.

## Consistently High Performance

all components are tested and complied with the latest code of practice.

## Economy

all Compact Units are designed with careful and specific calculations and operated on dynamic reality of hot water demand.

## Tailor Made Design

with the various types of hot water system to meet your unique and specific requirements.

## Energy Auditing

allows you to monitor energy expenses and maintain high efficiency of the hot water system.

## Remote Control

with the PLC controller of Heat Transfer Compact Unit, temperature, flow rate and pressure can be modulated due to low demand. This means energy saving and reduced environmental impact.





## WHY IES HEAT TRANSFER COMPACT UNIT?

Our comprehensive package provides you a hassle-free solution. We ensure a one-stop-shop solution from the full compatibility of components to the professional project management of the entire project. The package option delivered to site offers wide benefits – from compatibility of components, to the simplification of on-site project management.

## THE CONCEPT DESIGN

From the basic information on flow rate, temperature, heat load, components to the space consumption, our skillful design team can offer a swift mechanical, thermal and electrical and package solution.

In the selection of equipment, we endeavor to offer most energy efficient design by ensuring synergy between all the package components. As a provider of package systems, we have in depth knowledge of the entire system requirement.

We engage in the early stages of design, planning and work closely with consultants, contractors and your team, to ensure that the entire site design integrity is carefully assessed and successfully implemented.

## THE CONTRACT

**IES** designs and will produce the project documentation, which detailed the scope and critical dimensions of the package.

Our team is professional with attention to all details of the project and will liaise closely with you, to ensure that the best solution is being offered for your project.

Once the project plan is finalized, we dedicate a project engineer to oversee the whole project and provide timely and updated, information to you.



# ON-SITE TIME

Off-site fabrication of a package simplifies the Project Management tasks:

- No missing or forgotten components
- Minimal and simple site connection
- Only approved supplier to provide guaranteed "performance" for the complete hot water system
- Minimize the usage of expensive site labor and effectively manage resources
- Complete in-factory tested package unit delivered to a pre-agreed schedule
- Customized system design with built-in serviceability

# THE SERVICE

**IES** Engineers have years of experience and fully understand the unique requirement of different types of building or hot water applications.

We offer you comprehensive solutions throughout the contract, from initial concept until implementation of the project. The package and all individual components bear the standard **IES** warranty period of 12 months. Extended warranty period can also be arranged to suit your specific contract requirements.

Optionally, **IES** can offer comprehensive testing & commissioning, overhaul service and regular maintenance throughout the lifetime of the package.

At **IES**, service excellence and available resources are important to us. Whether you have a technical issue or an after-sales service question, our representatives are available to provide prompt answers and solutions.





# APPLICATION FOR COMPACT UNIT

## DIRECT HEATING

The direct hot water supply system consists various of environmental friendly products such as solar collector panel, heat pump and high efficient plate type heat transfer compact unit.

The primary circuit of hot water shall maintain (70°C) at all the time. Solar collector panel shall firstly produce hot water (70°C) of primary circuit with heat pump and electric hot water calorifier for booster and back up. The secondary circuit of cold water (15°C) shall be heated up to 60°C~65°C via IES Heat Transfer Compact Unit for the supply of central hot water system.

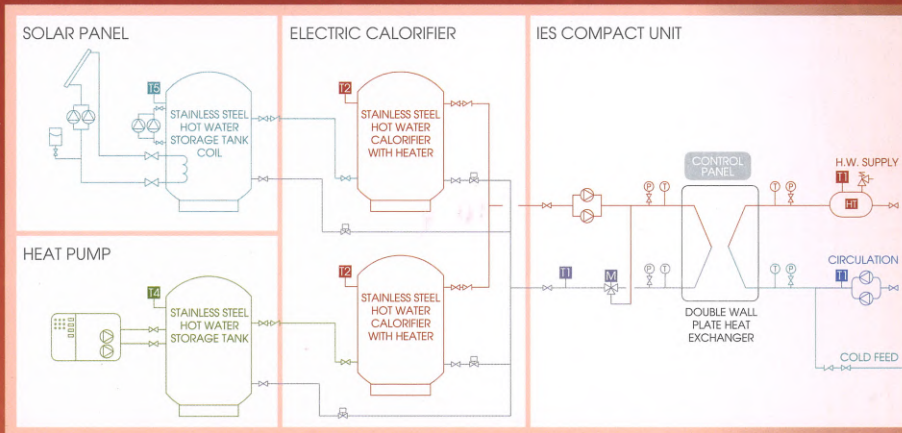
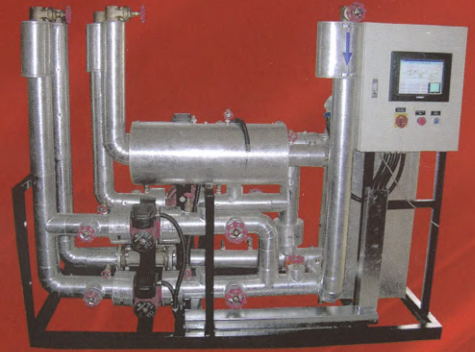

## INDIRECT HEATING

The indirect hot water supply system consists of heat up in two stages. In the first stage, cold water is fed into IES Preheat Heat Transfer Compact Unit and to be heated up from 15°C to 43°C by means of A/C Heat Recovery Chiller. The warmed water (43°C) is then fed into IES Booster Heat Transfer Compact Unit and to be heated up to 60°C~65°C by means of high efficiency hot water condensing boiler. The hot water is then fed into hot water storage tank for the supply of central hot water system.

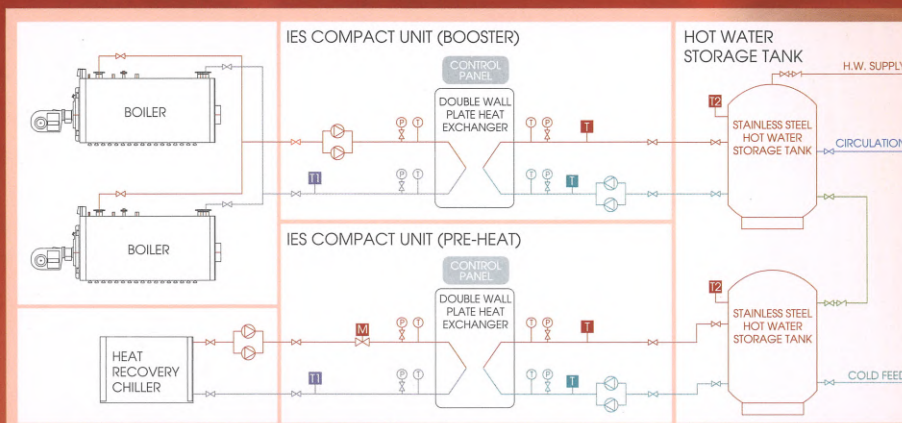



## SWIMMING POOL HEATING

IES compact unit is widely used in swimming pool heating and cooling application. As the swimming pool water temperature is monitored and controlled continuously, it is now possible to enjoy full-year indoor or outdoor swimming season.

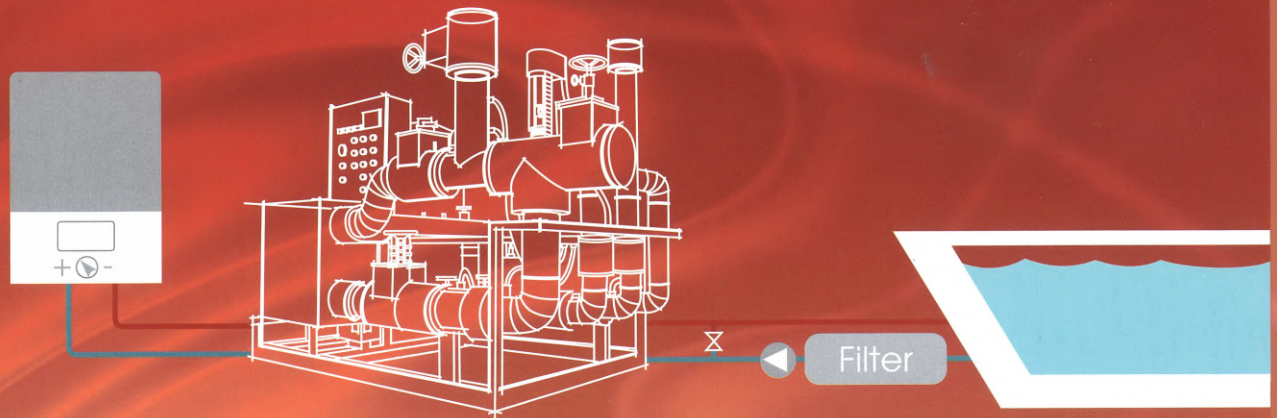

## SPACE HEATING

Some commercial building, hospital and hotel required heating and the purpose of space heating is to keep the space warm. High efficient IES's Compact Unit can be designed for process space heating applications by the heat source of boiler, heat pump or heat recovery chiller, etc. IES's Compact Unit with built-in plate type heat exchanger built for efficient heat transfer from one medium to another by indirect heating.

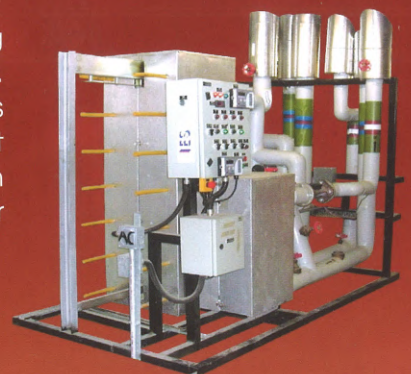

## DISTRICT COOLING

IES district cooling compact unit, is most suitable for construction such as office building, factory, hospital and high rise building. Equipped with high efficiency plate type heat exchanger and modulating function, energy saving can be easily achieved.

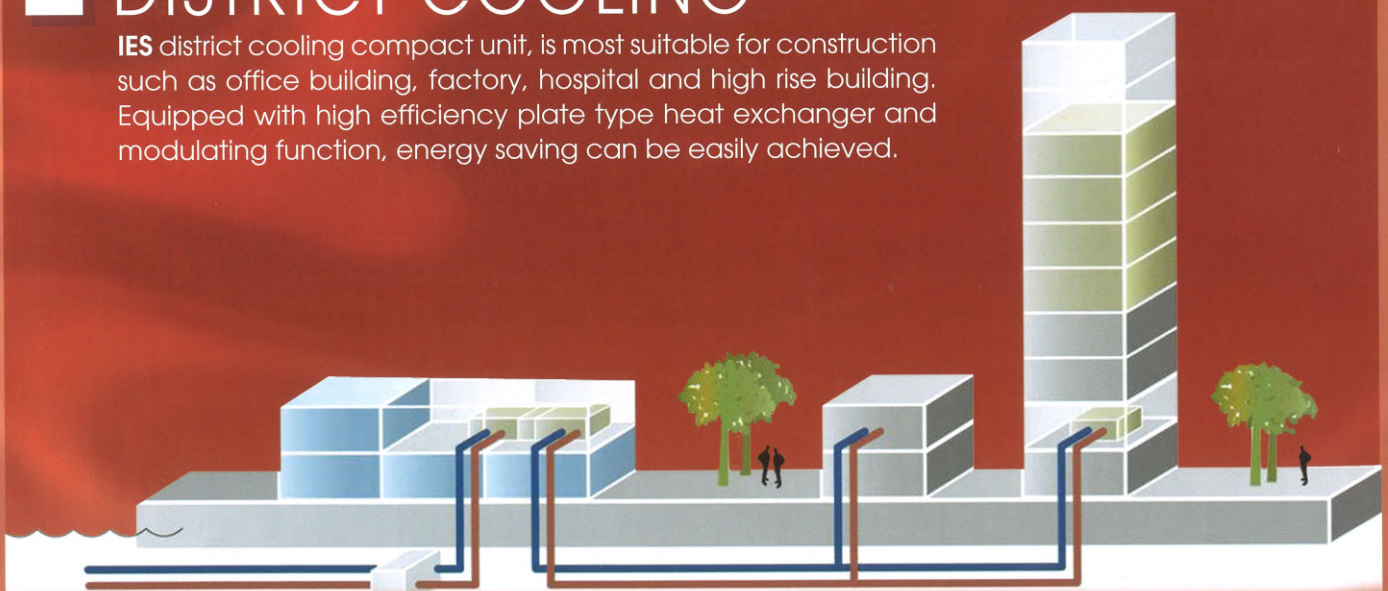



# PUMP SET APPLICATION

**IES** pump set station is specially designed for water pressure booster, solar system and hot water circulation. All calculation, design and selection are performed by our professional and experienced engineers to meet different applications & requirements, taking into account of different parameters such as flow rate, pressure head, working temperature and etc.

## BOOSTER PUMP SET

Booster pump set provides a constant and stable pressure level for water supply. Fully automatic control system with manual over-ride function, failure change-over function, low water level and high pressure alarm is the fundamental standard of our booster pump set.



## HOT WATER CIRCULATION PUMP SET

In domestic hot water circuits, hot water circulation pump set is employed for the circulation of liquids in heating system. It regulates the constant supply and return of hot water at a desired temperature. All **IES** hot water circulation pump sets are equipped with programmable logic controller (PLC) to fulfill the unique operation requirement.

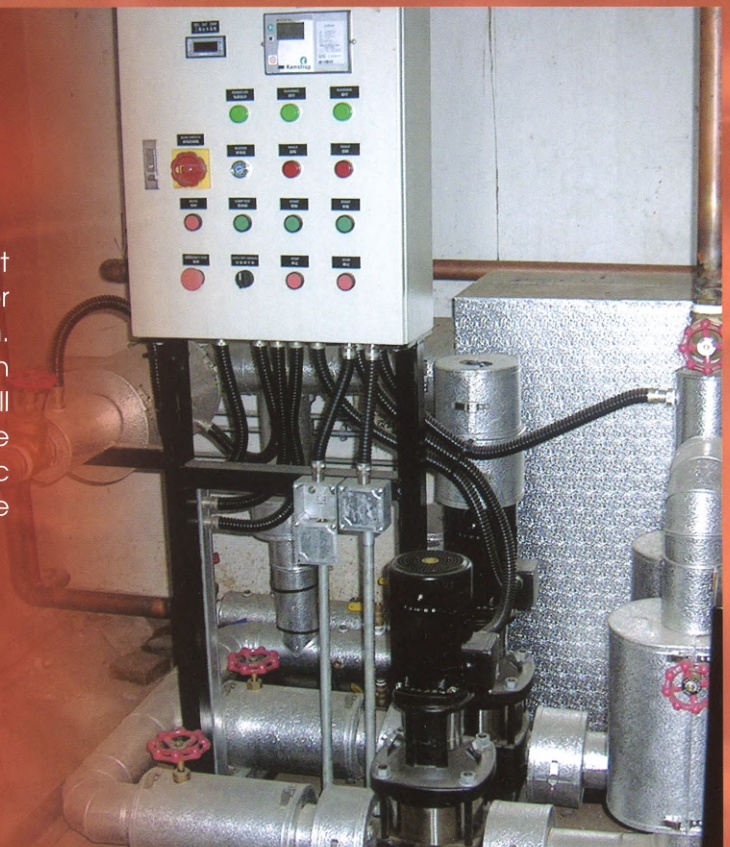



## VSD PUMP SET

VSD pump set, equipped with proportional integral (PI) controller, adjusts and controls the rotation speed of pump, is the best way to keep the water supply pressure at a stable and desired level even at the highest and the lowest water demand.



## SOLAR SYSTEM PUMP SET

In domestic hot water circuits, hot water circulation pump set is employed for the circulation of liquids in heating system. It regulates the constant supply and return of hot water at a desired temperature. All **IES** hot water circulation pump sets are equipped with programmable logic controller (PLC) to fulfill the unique operation requirement.

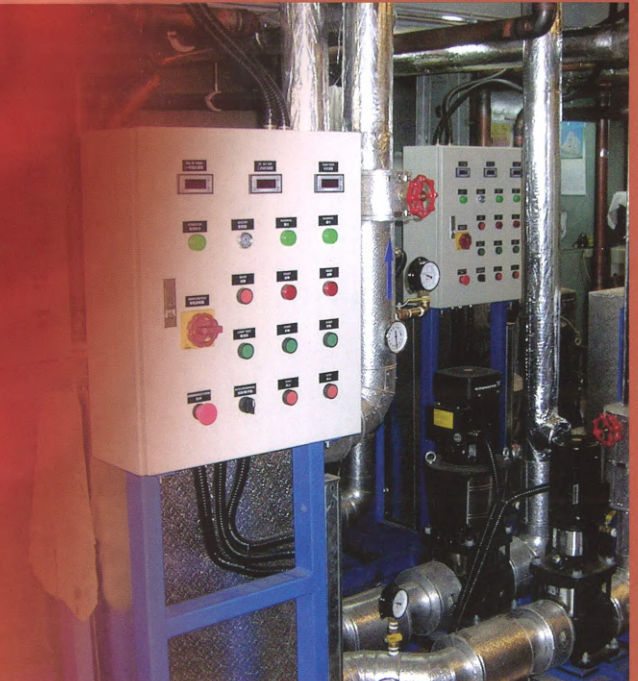

## MODEL REFERENCE

### IPU-01kW-BP-210V-DP

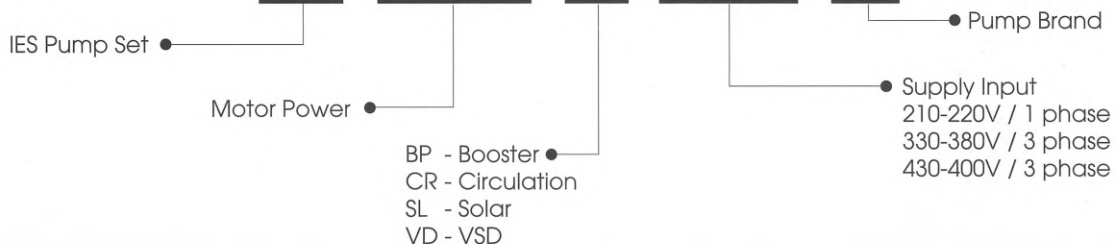



# COMPACT UNIT

## DIMENSION RANGE

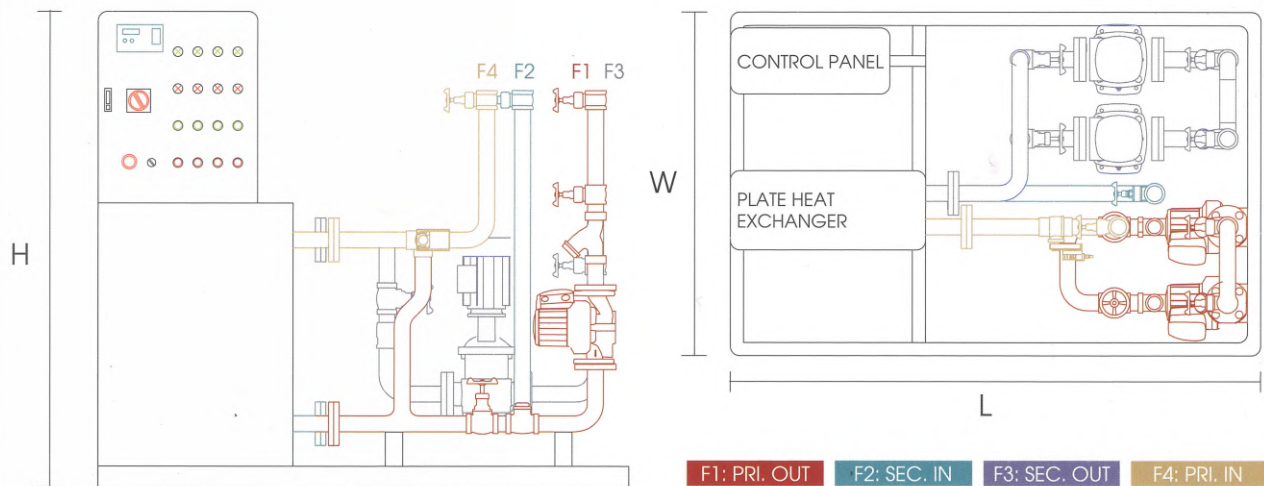

## MODEL REFERENCE

### ICU-0500-S 14 S W

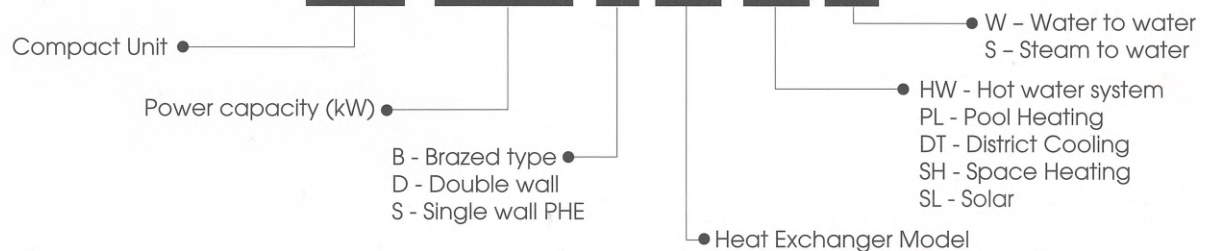

## NORMATIVE DIMENSION

70-50 °C / 15-60 °C	Connection Size		Dimensions (mm)			Weight (Kg)
Capacity (Kw)	Primary Side F1/F4	Secondary Side F2/F3	L	W	H	
200	32	32	1400	750	1500	250
400	50	40	1400	800	1500	400
800	80	50	1600	1000	1500	750
1200	100	65	1600	1000	1600	850
1500	100	80	1800	1200	1600	900
2000	100	80	1800	1200	1600	1200
2500	150	100	2000	1400	1800	1500
3000	150	100	2000	1400	1800	1800
4000	200	150	2200	1600	1800	2100
5000	200	150	3000	2200	2000	2400



# JOB REFERENCE



**HONG KONG** Castle Peak Hospital



**HONG KONG** Disneyland Resort Hotel

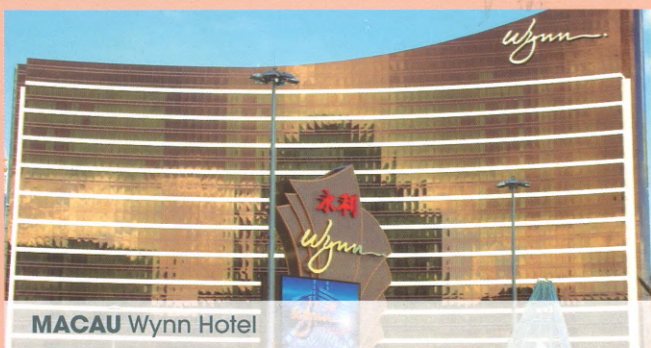

**MACAU** Wynn Hotel



**MACAU** Crown Hotel



**SINGAPORE** Marina Bay Sands

## HONG KONG

Castle Peak Hospital  
North Lantau Hospital  
North District Hospital  
TKO Hospital  
Prince of Wales Hospital  
Princess Margaret Hospital  
  
Crowne Plaza Hotel  
Mandarin Oriental Hotel  
Hong Kong Central Landmark Hotel  
Disneyland Hollywood Hotel  
Renaissance New World Hotel  
Regal Riverside Hotel  
The Mira Hotel  
W Hotel  
  
Tamar Government Headquarter  
EMSD Headquarter  
Hong Kong Sports Institute  
The Hong Kong Institute of Education  
Cathay Pacific Passenger Lounge

## MACAU

Sands Casino, Macau  
Venetian Parcel I  
Venetian Parcel II, Four Seasons Hotel  
Wynn Macau Hotel  
Galaxy Resort  
Altira Hotel, Macau  
New Grand Lisboa, Macau  
Grand Waldo, Macau  
MGM Grand, Macau  
Ponte 16 Macau Hotel

## VIETNAM

Vietnam Best Western Sapaly Hotel  
Times Square

## SINGAPORE

Singapore Marina Bay Sands  
Singapore Island Country Club  
National University of Singapore  
V-Hotel  
Traders Hotel





SHENZHEN

GUANGZHOU

HONG KONG

MACAU

DONGGUAN

HAINAN

SHANGHAI

VIETNAM

CHEUNGDU

SINGAPORE

# CONTACT

## HEADQUARTERS IES ENGINEERING (HONG KONG) LIMITED

Flat Q, 11/F., Block 3, Camelpoint Building,  
60 Hoi Yuen Road, Kwun Tong, Kowloon, Hong Kong.

Tel : 852 2992 0830      Fax : 852 2992 0860  
E-mail : [info@ieshk.com.hk](mailto:info@ieshk.com.hk)

## FACTORY IES-Rudert Company Limited

No. 2 Hong Yuan Road, Tangxia, Shigu,  
Dongguan, China

Tel : 86 769 8299 9399      Fax : 86 769 8779 4620

## REPRESENTATIVE OFFICE

### MACAU

Tel : 853 2830 0112

E-mail : [sales@iesmo.com.mo](mailto:sales@iesmo.com.mo)

### SINGAPORE

Tel : 65 6338 4613

E-mail : [sales@iessg.com.sg](mailto:sales@iessg.com.sg)

### VIETNAM

Tel : 848 3854 7602

E-mail : [info@iesvn.com.vn](mailto:info@iesvn.com.vn)

### GUANGZHOU

Tel : 20 838 11745

E-mail : [sales@ies-rudert.com](mailto:sales@ies-rudert.com)



[www.ieshk.com.hk](http://www.ieshk.com.hk)